

**DESCRIPTION**

- 546 MHz SAW bandpass filter with 70 MHz bandwidth for satellite / DVB applications.
- 9 x 7 mm LCC package.
- RoHS compliant.

**TYPICAL PERFORMANCE**

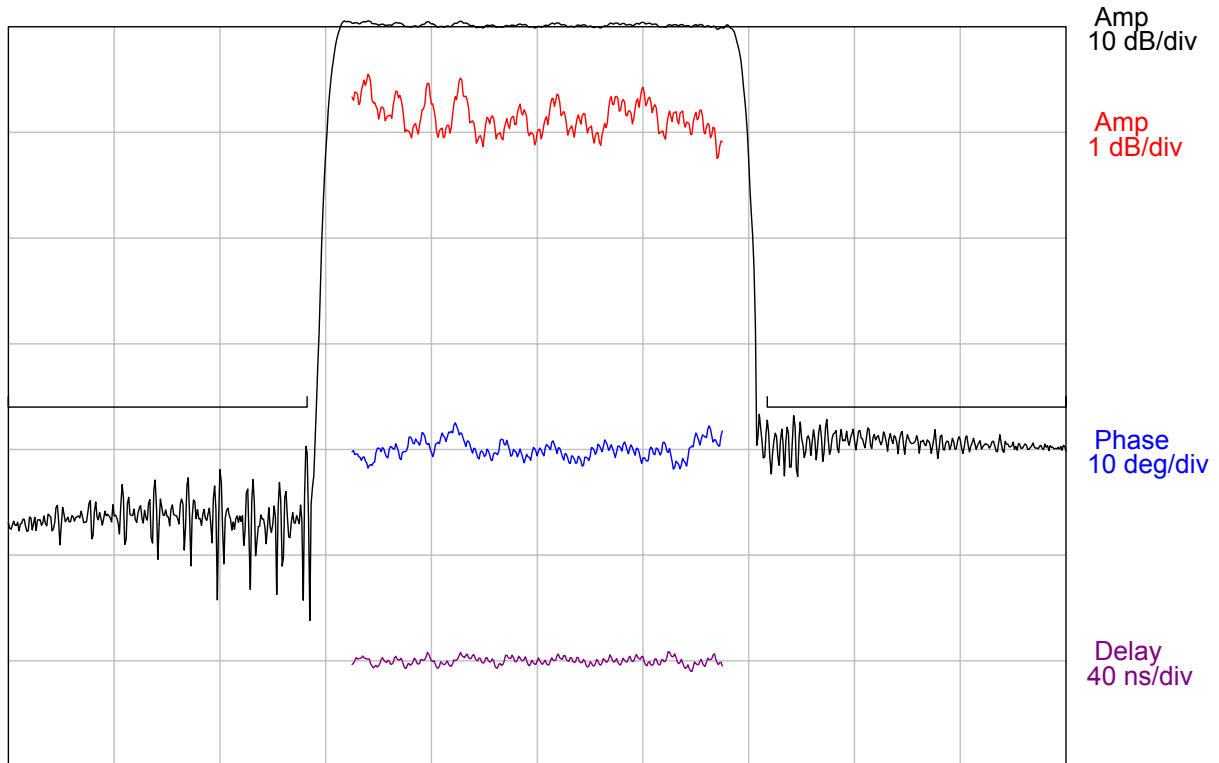

Center = 546 MHz, 20 MHz/div (250 kHz incr)

**S11 (446-646 MHz)**

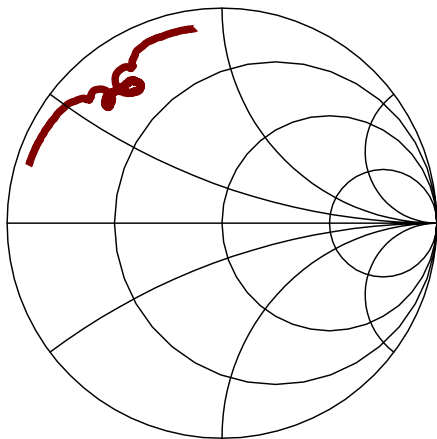

**S22 (446-646 MHz)**

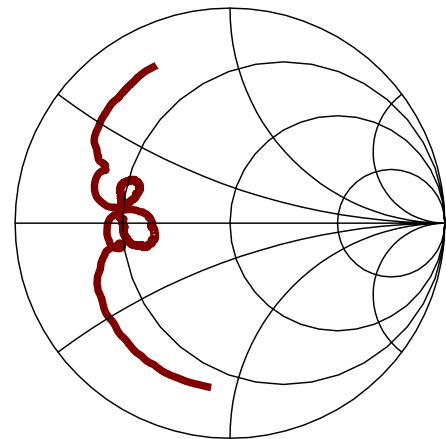

## SPECIFICATION

Parameter	Min	Typ	Max	Units
Center Frequency (Fc) <sup>1</sup>	545.0	546.0	547.0	MHz
Insertion Loss(@ Fc )	-	23.8	26	dB
1 dB Bandwidth <sup>2</sup>	70	75.4	-	MHz
36 dB Bandwidth <sup>2</sup>	-	83.2	87	MHz
Rejection (10 to 502.5 MHz)	36	40	-	dB
Rejection (589.5 to 700 MHz)	36	40	-	dB
Passband Amplitude ripple (Fc+/-35 MHz)	-	0.8	1	dB p-p
Passband GD ripple ( Fc+/-35 MHz) <sup>3</sup>	-	10	40	ns p-p
Absolute Delay	-	0.81	-	us
Source and Load impedance	-	50	-	Ω
Temperature Coefficient of Frequency	-	-72	-	ppm / °C
Ambient Temperature	-	25	-	°C

- Notes:
1. Mean of the 3 dB points.
  2. With respect to Fc.
  3. Measured using smoothing aperture of 1% of the swept bandwidth.

## MAXIMUM RATINGS

Parameter	Min	Max	Units
Storage Temperature Range	-40	85	°C
Input Power Level	-	10	dBm

## MATCHING CIRCUIT

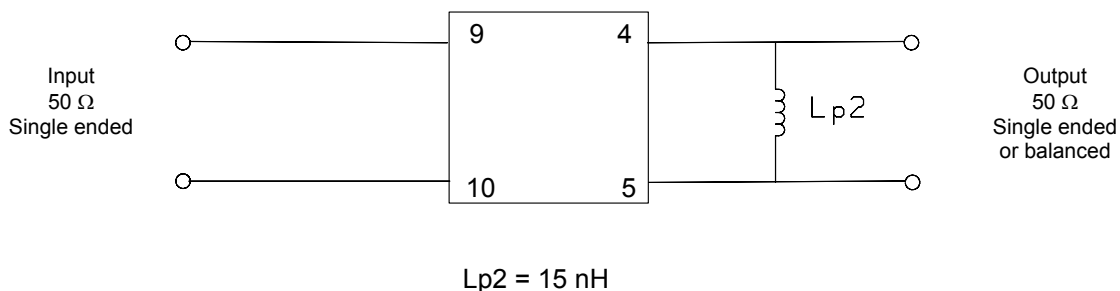

Notes:

- Recommend 2% toleranced matching components. Typical inductor Q=40.
- Matching value shown is for reference only and may change depending on board layout.

**PACKAGE OUTLINE**

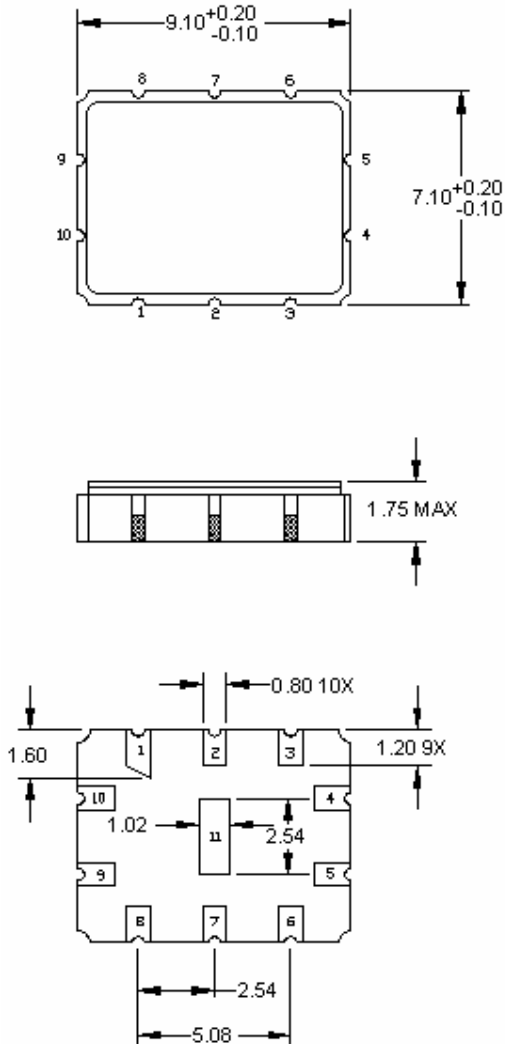

**SUGGESTED FOOTPRINT**

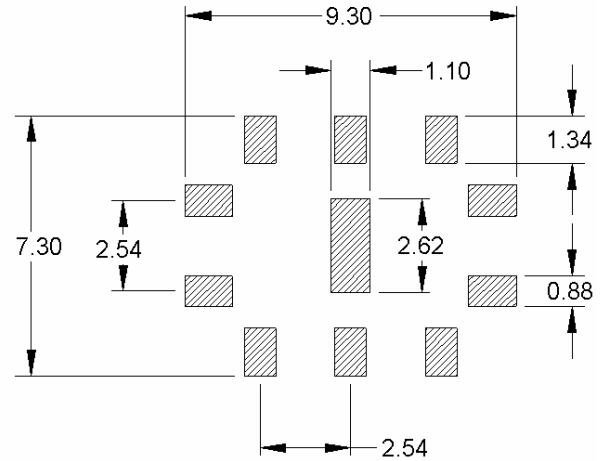

**Units:** mm

Tolerances are  $\pm 0.15$  mm except where indicated.

**Pad Configuration:**

- Input: 9
- Input return: 10
- Output: 4
- Output return: 5
- Ground: All other pads
- Package Material:
- Body:  $Al_2O_3$  ceramic
- Lid: Kovar, Ni plated
- Terminations: Au plating 1  $\mu$ m min, over a 1.3-8.9  $\mu$ m Ni plating

**MARKING**

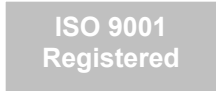
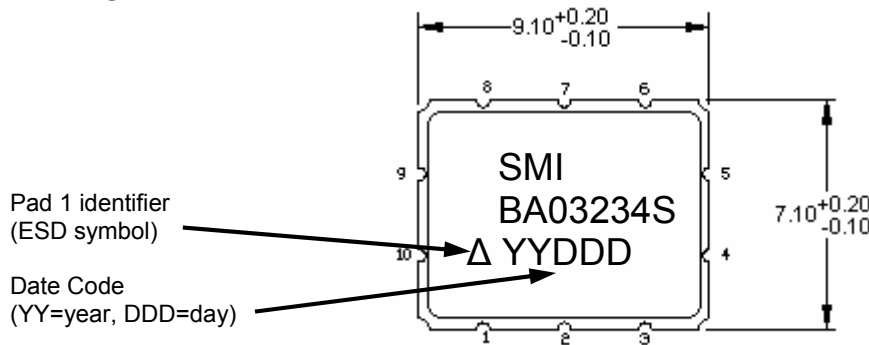

All specifications are believed to be accurate and reliable. However, Spectrum Microwave reserves the right to make changes without notice.  
© 2010 All rights reserved.